

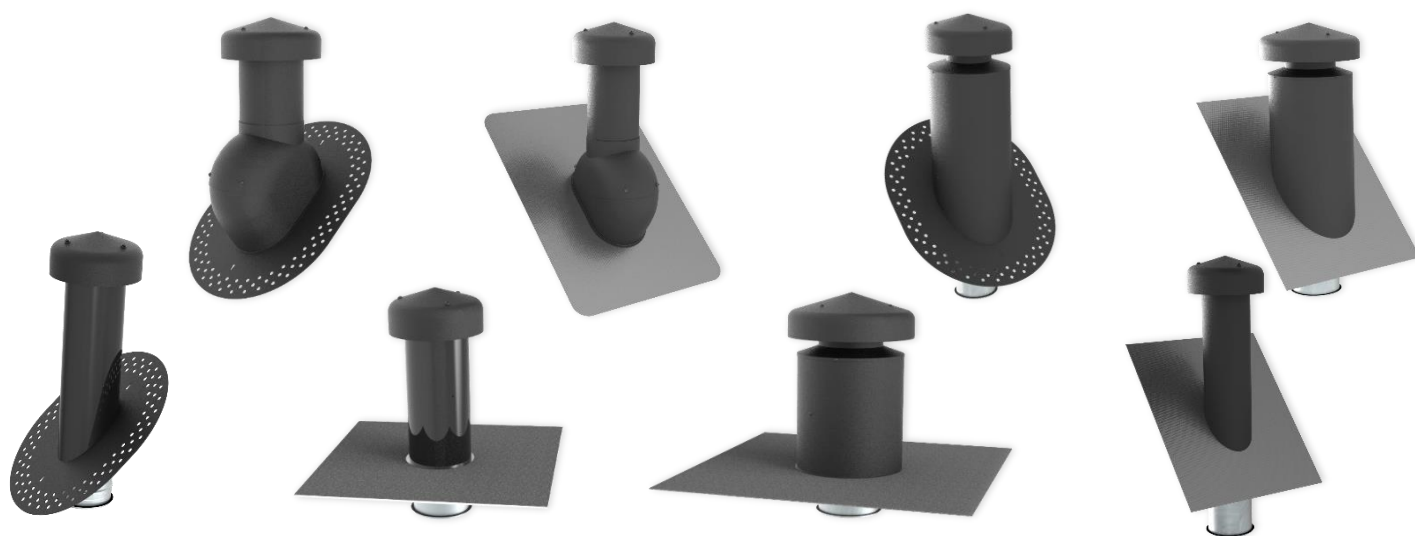

FIXNORDIC.DK

UniVent From FIXNORDIC



DATASHEET

UniVent
From Fixnordic

PRODUCT DESCRIPTION

UniVent

Universal ventilation cowl system for efficient ventilation and secure penetration of roof surfaces

The series of universal ventilation cowls for flat and pitched roof surfaces consists of a variety of products based on one common idea of defining an overall efficient and easy-to-mount product system of standard Ø125, Ø160 and Ø200 mm high-quality ventilation cowls. The cowls can be used and specified as a penetration solution for insulated and non-insulated ventilation penetrations on roof surfaces made with different types of roofing: tile, eternit, bitumen membrane, etc.

When installing or designing ventilation solutions, it will therefore be possible to choose one standard cowl based on a wide product range, regardless of whether the application is an installation on a flat, pitched, cold or warm roof. This reduces the time spent on design and ensures the basis for an efficient and technically correct assembly.

The products are all made from aluminium components and come with a black lacquered structure. The insulated product variants comply with the fire safety requirements for insulation, according to DS 428, and based on DS 428, fire safety tests have been carried out on the non-insulated product variants, and a good fire technical resistance to a standard fire has been demonstrated for up to 60 min. (standard fire curve according to DBi ISO 834).

The non-insulated product variants are supplied with condensation protection, whereby the risk of condensation formation from humidified ventilation air is greatly reduced.

DESIGN AND ORDER PLACEMENT

For an increased overview of the different product variants when placing an order or for use in the design process, a complete product overview with characteristic product illustrations and outline of the intended uses of the product has been inserted on pages 7-8 of the data sheet.

The product overview also contains an overview of the various accessory products.

MATERIALS

Ventilation cowl:	Aluminium
Condensation insert:	Aluminium
Pipe nipple:	Galvanised steel
Insulation:	Fiberglass insulation (insulated units only)
Roof membrane:	Bitumen membrane or Fast Flash (only variants with integrated membrane)

INSTALLATION

For more information about detailed installation, please contact FIXNORDIC directly.

DIMENSIONS AND TECHNICAL CHARACTERISTICS OF PRODUCT VARIANTS FOR BITUMEN MEMBRANE

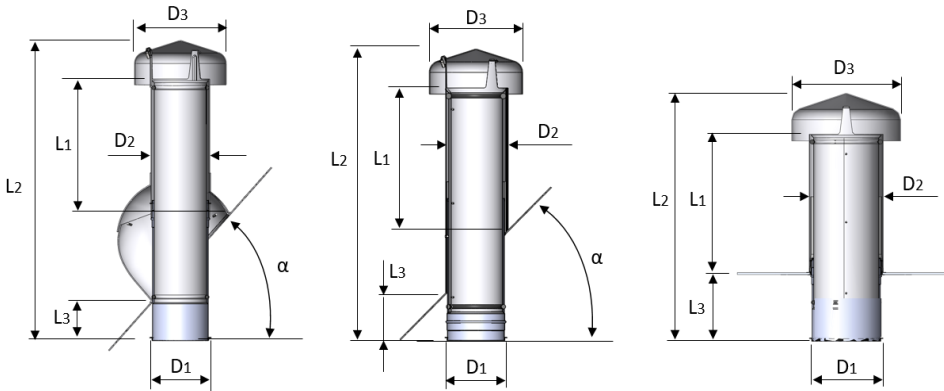

DIMENSION OVERVIEW - NON-INSULATED VARIANTS

Variant	D1 [mm]	D2 [mm]	D3 [mm]	L1 [mm]	L2 [mm]	L3 [mm]	L4 [mm]	α [°]
Ø125 Flat roof	DN125*	DN125	Ø200	300	500	130	500	-
Ø125 Inclined roof	DN125*	DN125	Ø200	300	500**	130	430	10 - 48
Ø125 Fixed angle	DN125*	DN125	Ø200	300	650**	100	480	10 - 48
Ø160 Flat roof	DN160*	DN160	Ø250	300	510	130	500	-
Ø160 Inclined roof	DN160*	DN160	Ø250	300	500**	130	465	10 - 48
Ø160 Fixed angle	DN160*	DN160	Ø250	300	700**	100	465	10 - 48

* Pipe nipple dimension acc. to DS/EN 1506
 ** This dimension depends on the specific roof inclination

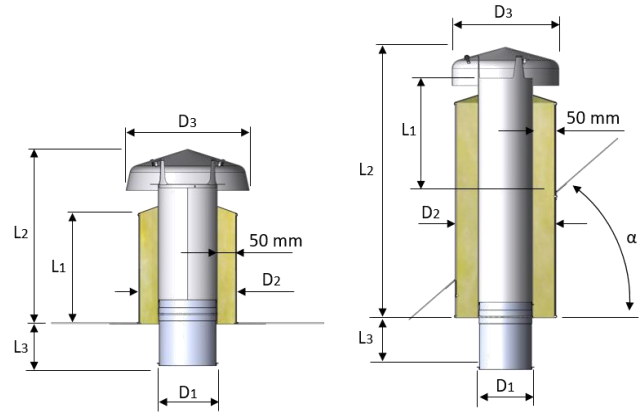

DIMENSION OVERVIEW - INSULATED VARIANTS

Variant	D1 [mm]	D2 [mm]	D3 [mm]	L1 [mm]	L2 [mm]	L3 [mm]	L4 [mm]	α [°]
Ø125 Flat roof	DN125*	Ø236	Ø250	300	455	130	700	-
Ø125 Inclined roof	DN125*	Ø236	Ø250	300	500**	130	506	10 - 48
Ø160 Flat roof	DN160*	Ø270	Ø320	300	455	130	750	-
Ø160 Inclined roof	DN160*	Ø270	Ø320	300	500**	130	546	10 - 48
Ø200 Flat roof	DN200*	Ø312	Ø420	300	502	130	800	-
Ø200 Inclined roof	DN200*	Ø312	Ø420	300	500**	130	586	10 - 48

* Pipe nipple dimension acc. to DS/EN 1506
 ** This dimension depends on the specific roof inclination

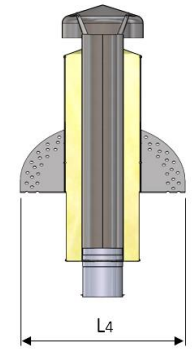

DIMENSIONS AND TECHNICAL CHARACTERISTICS OF PRODUCT VARIANTS FOR TILES, ETERNIT, ETC.

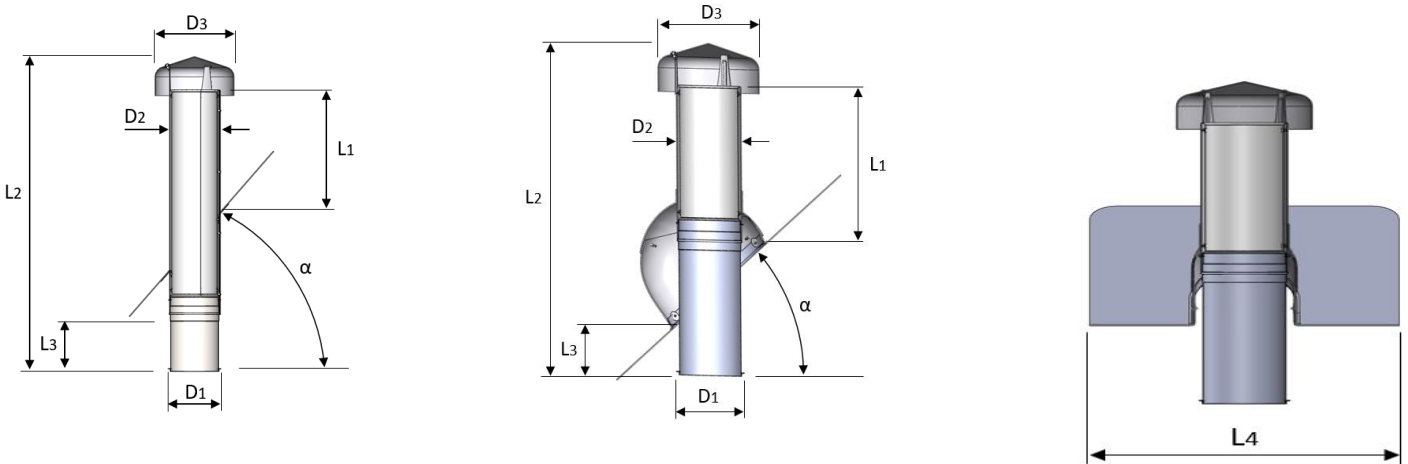

DIMENSION OVERVIEW - NON-INSULATED VARIANTS								
Variant	D1 [mm]	D2 [mm]	D3 [mm]	L1 [mm]	L2 [mm]	L3 [mm]	L4 [mm]	α [°]
Ø125	DN125*	Ø128,25	Ø200	300	645	100**	455	10 - 48
Ø125 Fixed angle	DN125*	Ø129	Ø200	300	500**	140	430	10 - 48
Ø160	DN160*	Ø163,3	Ø250	300	630	40**	500	10 - 48
Ø160 Fixed angle	DN160*	Ø163,5	Ø250	300	500**	140	465	10 - 48

* Pipe nipple dimension acc. to DS/EN 1506



DIMENSION OVERVIEW - INSULATED VARIANTS								
Variant	D1 [mm]	D2 [mm]	D3 [mm]	L1 [mm]	L2 [mm]	L3 [mm]	L4 [mm]	α [°]
Ø125	DN125*	Ø236	Ø250	300	760**	260	540	0 - 48
Ø160	DN160*	Ø270	Ø320	300	800**	260	560	0 - 48
Ø200	DN200*	Ø312	Ø420	300	800**	260	720	0 - 48

* Pipe nipple dimension acc. to DS/EN 1506
 ** This dimension depends on the specific roof inclination

PRODUCT SPECIFICATIONS

The diagrams below indicate the static pressure losses for the dimensioning design for the two dimension variants $\text{\O}125$ and $\text{\O}160$ mm for intake and outtake, respectively.

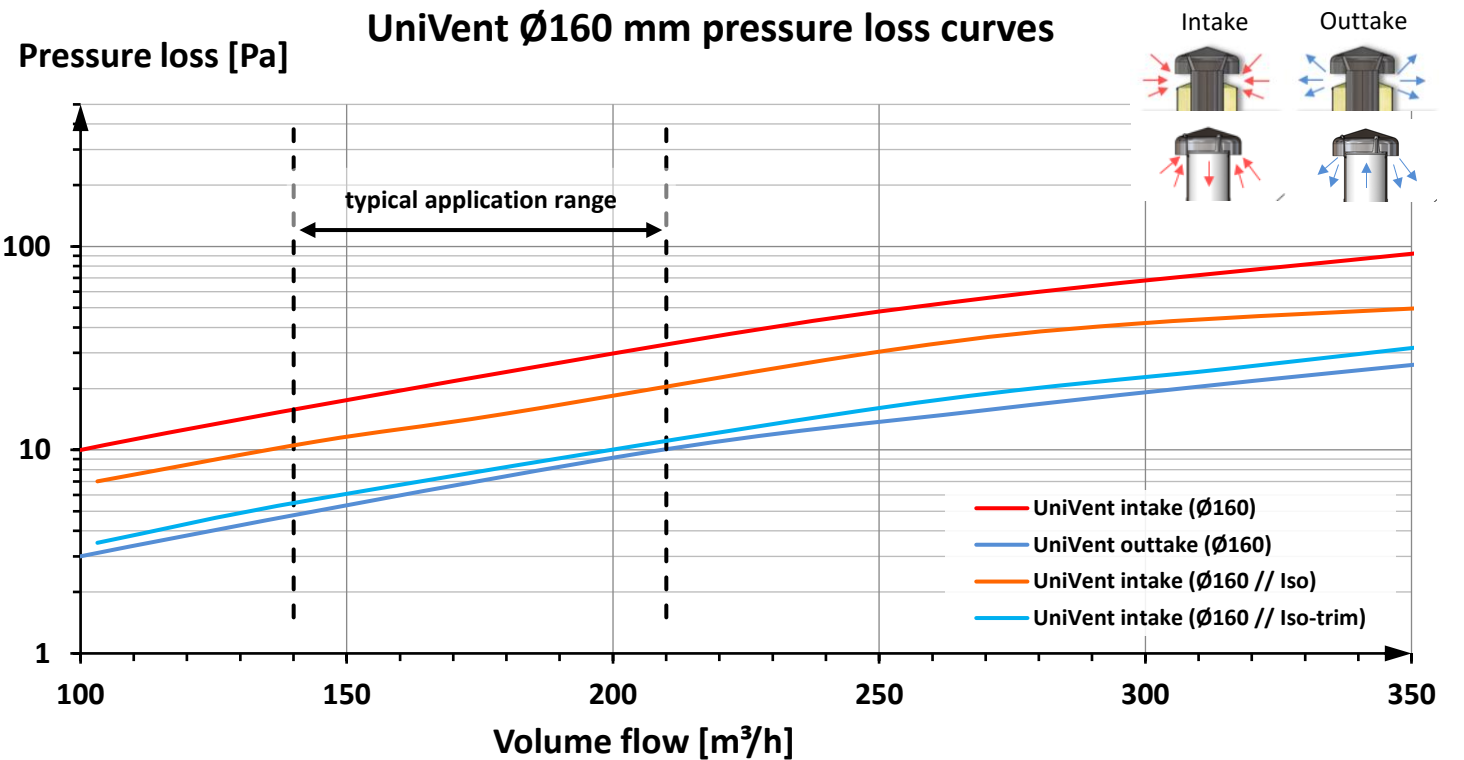
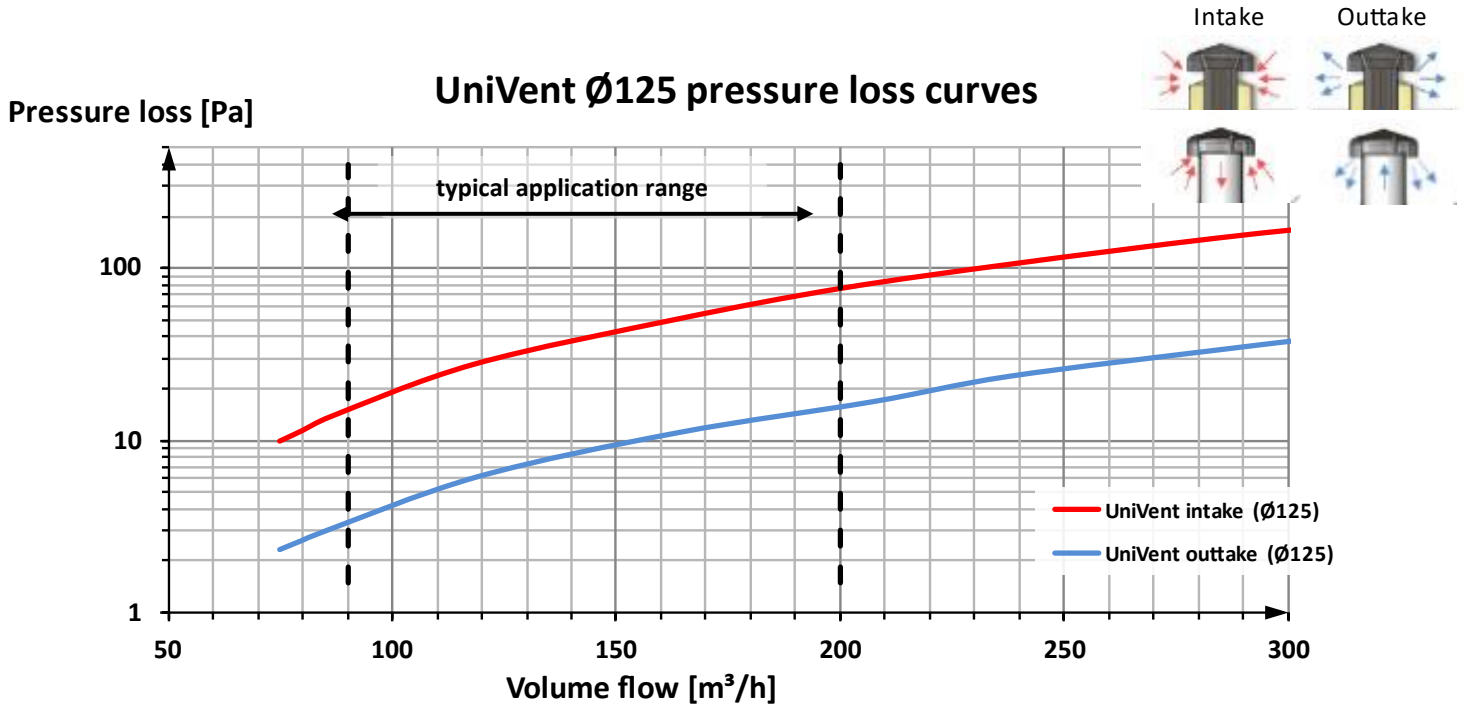





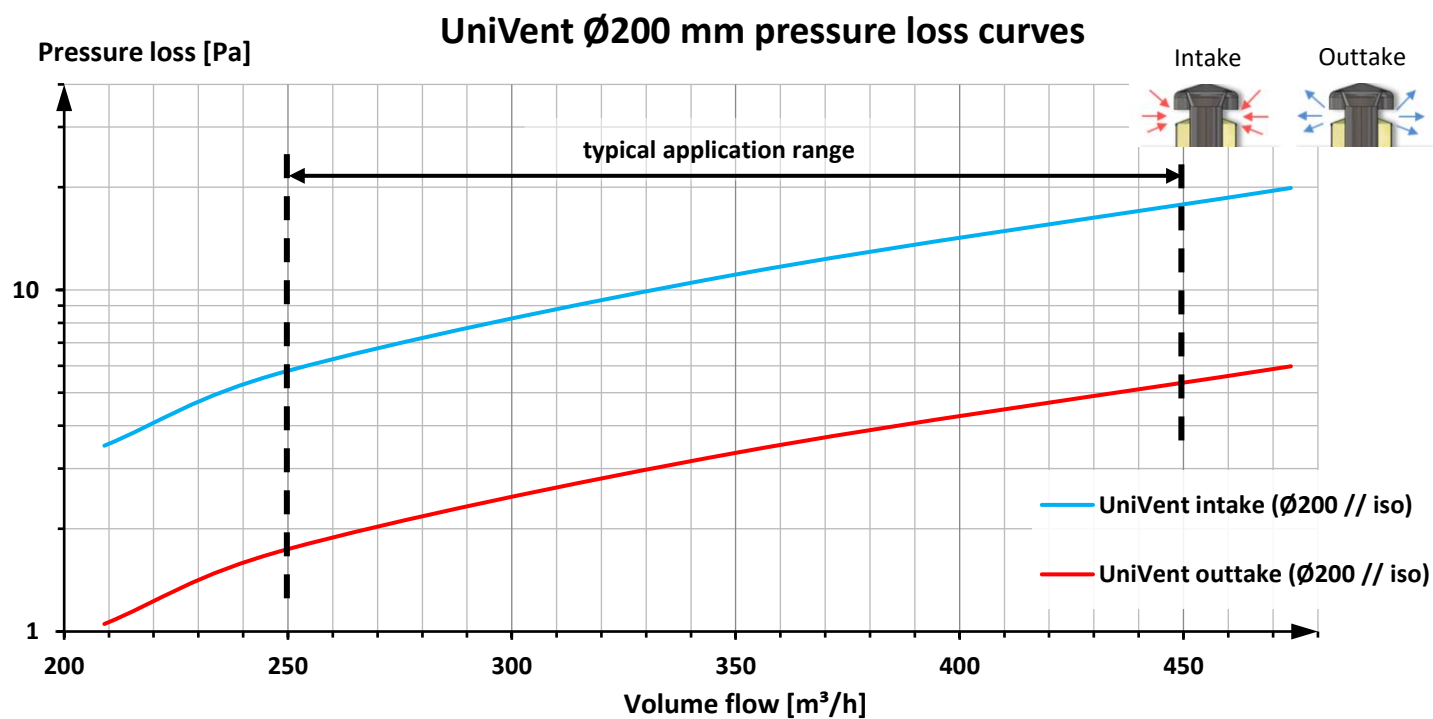



















PRODUCT SPECIFICATIONS

The diagram below indicates the static pressure losses for the dimensioning design for the dimension variant $\text{\O}200$ mm for intake and outtake, respectively.











PRODUCT OVERVIEW

UniVent application matrix				
Standard product variants				
Roof type	Roof incline	Dimension	Article numbers	Product illustration
	0° - 7°	Ø125	9112500-101	
		Ø160	9116000-101	
		Ø200	9120000-101	
	0° - 7°	Ø125	91125000-101	
		Ø160	91160000-101	
	0° - 7°	Ø125	9012500-101	
		Ø160	9016000-101	
	0° - 7°	Ø125	90125000-101	
		Ø160	90160000-101	
	10° - 48°	Ø125	9012548-191	
		Ø160	9016048-191	
	10° - 48°	Ø125	9012548-520	
			9012548R-5xx (red)	
			9012599R-5xx (red)	
		Ø160	9016048-520	
			9016048R-5xx (red)	
9016099R-5xx (red)				
Project product variants				
Roof type	Roof incline	Dimension	Article numbers	Product illustration
	10° - 48°	Ø125	9012599-191	
		Ø160	9016099-191	
	10° - 48°	Ø125	9112599-191	
		Ø160	9116099-191	
		Ø200	9120099-191	
	10° - 48°	Ø125	91125990-191	
		Ø160	91160990-191	
	10° - 48°	Ø125	91125991-191	
		Ø160	91160991-191	
		Ø200	91200991-191	
	10° - 48°	Ø125	911259901-191	
		Ø160	911609901-191	
	10° - 48°	Ø125	9012599-520	
		Ø160	9016099-520	

UniVent products are developed by and produced by FIXNORDIC A/S.

PRODUCT OVERVIEW

UniVent application matrix				
Project product variants - continued				
	10° - 48°	Ø125	9112599-520	
			9112599R-5xx (red)	
		Ø160	9116099-520	
			9116099R-5xx (red)	
		Ø200	9120000-520	
			9120099R-5xx (red)	
	0° - 48°	Ø125	91125600	
			91125900	
		Ø160	91160600	
			91160900	
Membrane penetrations for vapour barrier / roofing underlay				
Roof type	Roof incline	Dimension	Article numbers	Product illustration
	Bitumen membrane	Ø100	100101-104	
		Ø125	125101-104	
		Ø160	160101-104	
		Ø200	200101-104	
	Foil underlay	Ø100	100xxx-xxx	
		Ø125	125xxx-xxx	
		Ø160	160xxx-xxx	
		Ø200	200xxx-xxx	

UniVent products are developed by and produced by FIXNORDIC A/S.